

---

Built-in compact  
combination microwave oven

---

Installation & user manual

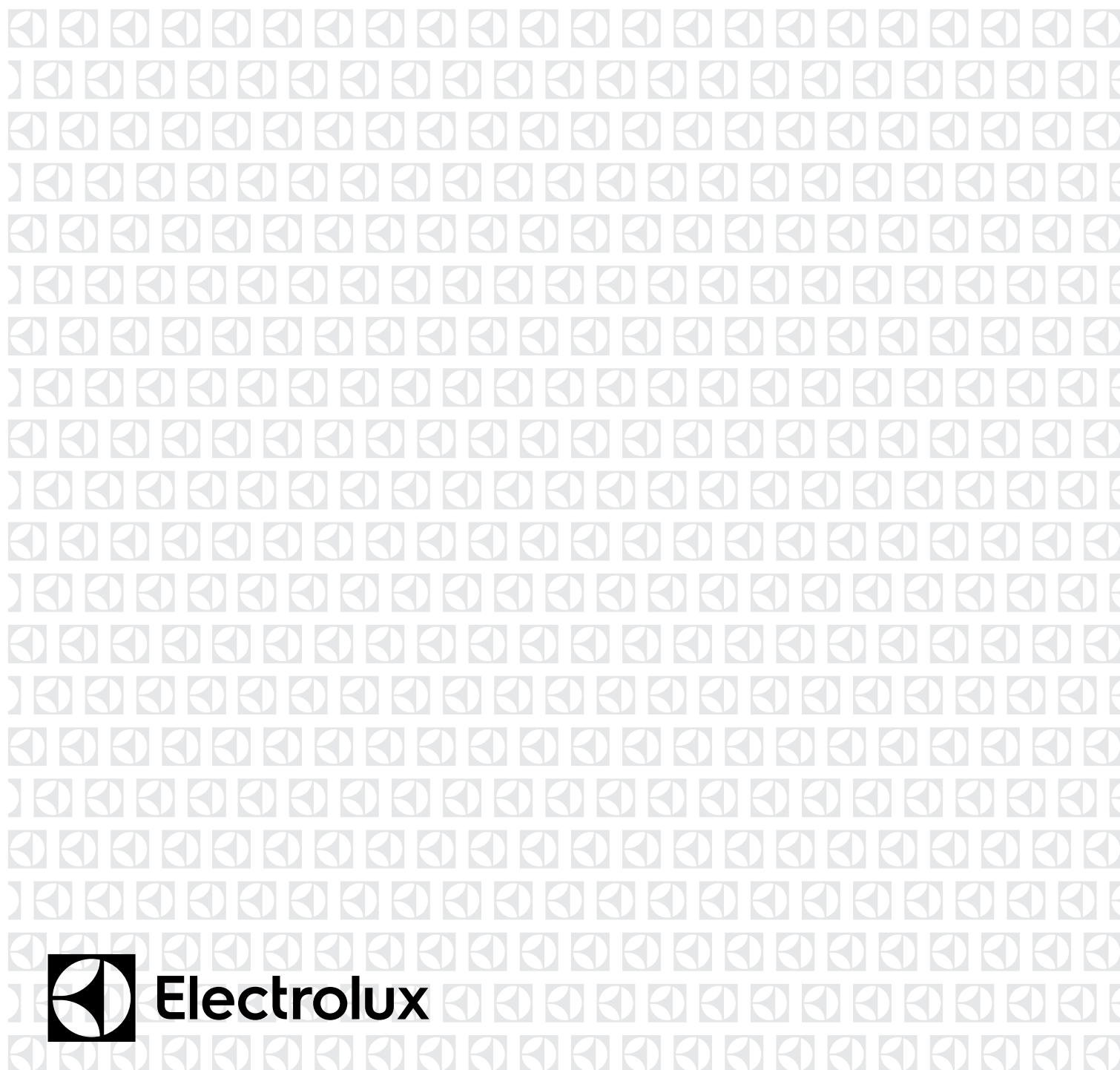

# WE'RE THINKING OF YOU

## CONGRATULATIONS

Dear customer,

Thank you for purchasing an Electrolux microwave oven. You've chosen a product that brings with it decades of professional experience and innovation. Ingenious and stylish, it has been designed with you in mind. So whenever you use it, you can be safe in the knowledge that you'll get great results every time.

Welcome to Electrolux.



### WARNING

This symbol indicates information concerning your personal safety.



### CAUTION

This symbol indicates information on how to avoid damaging the cooker or cabinet.



### IMPORTANT

This symbol indicates tips and information about use of the cooker.



### ENVIRONMENT

This symbol indicates tips and information about economical and ecological use of the cooker.

*NOTE: Model codes shown in this manual are the generic code. Your product will also include a two letter suffix which denotes colour and series level.*

## CONDITIONS OF USE

This appliance is intended to be used in household and similar applications such as:

- Staff kitchen areas in shops, offices and other working environments
- Farm houses
- By clients in hotels, motels and other residential type environments
- Bed and breakfast type environments
- Catering and similar non-retail applications

Record model and serial number here:

Model number: \_\_\_\_\_

Serial number: \_\_\_\_\_

## CONTENTS

Important instructions _____	3
Product description _____	6
Before using your appliance for the first time _____	8
Daily use _____	10
Microcombi operation _____	10
Automatic programmes _____	13
Defrosting programmes _____	14
Time setting _____	15
Cooking guide _____	16
Care and cleaning _____	29
Technical data _____	30
Troubleshooting _____	31
Energy and environment tips _____	32
Installation _____	33
Warranty _____	35

## REGISTER YOUR PRODUCT

Please visit our website [www.electrolux.com.au](http://www.electrolux.com.au) and register your product if you haven't done so already.

The symbols you will see in this booklet have these meanings:

## INFORMATION ON DISPOSAL FOR USERS



### ENVIRONMENT!

- Most of the packaging materials are recyclable. Please dispose of these materials through your local recycling depot or by placing them in appropriate collection containers.
- If you wish to discard this product, please contact your local authorities and ask for the correct method of disposal.

# IMPORTANT INSTRUCTIONS

## Important Information that may impact your Manufacturer's Warranty

Adherence to the directions for use in this manual is extremely important for health and safety. Failure to strictly adhere to the requirements in this manual may result in personal injury, property damage and affect your ability to make a claim under the Electrolux manufacturer's warranty provided with your product. Products must be used, installed and operated in accordance with this manual. You may not be able to claim on the Electrolux manufacturer's warranty in the event that your product fault is due to failure to adhere to this manual.

## BEFORE USING YOUR APPLIANCE

Before you use the appliance, we recommend that you read through the relevant sections of this manual, which provides the description of your appliance and its functions.

To avoid the risks that are always present when you use an appliance, it is important that the appliance is installed correctly and that you read the safety instructions carefully to avoid misuse and hazards.

We recommend that you keep this instruction booklet for future reference and pass it on to any future owners.

This appliance complies with the requirements of Australian Standards AS/NZS 60335.2.6 and AS/NZS 60335.2.25



### IMPORTANT

**Check for any damage or marks. If you find the appliance is damaged or marked, you must report it within 7 days if you wish to claim for damage/marks under the manufacturer's warranty. This does not affect your statutory rights.**

## IMPORTANT SAFETY INSTRUCTIONS

The microwave oven is intended for heating food and beverages. Drying of food or clothing and heating of warming pads, slippers, sponges, damp cloth and similar may lead to risk of injury, ignition or fire.

Damage caused by incorrect connection is not covered under warranty.

This appliance is intended for domestic use only. The appliance must only be used for the preparation of food and drink. The appliance must be supervised during operation. Only use this appliance indoors.

This appliance is not intended for use by persons (including children) with reduced physical, sensory or mental capabilities, or lack of experience and knowledge, unless they have been given supervision or instruction concerning use of the appliance by a person responsible for their safety.

Children should be supervised to ensure that they do not play with the appliance.

The appliances are not intended to be operated by means of an external timer or separate remote-control system.



### WARNING

#### Risk of fire!

- Combustible items stored in the cooking compartment may catch fire. Never store combustible items in the cooking compartment.
- When heating food in plastic or paper containers, keep an eye on the oven due to the possibilities of ignition.
- If smoke is observed, switch off or unplug the appliance and keep the door closed in order to stifle any flames



### WARNING

**Accessible parts may become hot during use  
Young children should be kept away.**



### WARNING

**Do not use harsh abrasive cleaners or sharp metal scrapers to clean the microwave oven door glass since they can scratch the surface, which may result in shattering of the glass.**

- Do not select a microwave power or time setting that is higher than necessary. Follow the information provided in this instruction manual.
- Never use the microwave to dry food.
- Never defrost or heat food with a low water content, e.g. bread, at too high a microwave power or for too long.
- Cooking oil may catch fire. Never use the microwave to heat cooking oil on its own.



### WARNING

#### Risk of explosion!

Liquids and other food may explode when in containers that have been tightly sealed. Never heat liquids or other food in containers that have been tightly sealed.

Only use utensils that are suitable for use in microwave ovens

#### Risk of serious damage to health!

- The surface of the appliance may become damaged if it is not cleaned properly. Microwave energy may escape. Clean the appliance on a regular basis, and remove any food residue immediately. Always keep the cooking compartment, door seal, door and door stop clean; see also section Care and cleaning.

## IMPORTANT INSTRUCTIONS (CONTINUED)



### WARNING

If the door or door seals are damaged, the oven must not be operated until it has been repaired by a competent person.



### WARNING

**It is hazardous for anyone other than a competent person to carry out any service or repair operation that involves the removal of a cover which gives protection against exposure to microwave energy.**

- Microwave energy may escape if the cooking compartment door or the door seal is damaged. Never use the appliance if the cooking compartment door or the door seal is damaged. Contact the after-sales service.
- Microwave energy will escape from appliances that do not have any casing. Never remove the casing.

For any maintenance or repair work, contact the after sales service.



### WARNING

**Risk of electric shock!  
Incorrect repairs are dangerous.**

Repairs may only be carried out and damaged power cables replaced by one of our trained aftersales technicians. If the appliance is defective, switch off the isolation switch or switch off the circuit breaker in the fuse box to isolate from the mains power supply. Contact the after sales service.

- The cable insulation on electrical appliances may melt when touching hot parts of the appliance. Never bring electrical appliance cables into contact with hot parts of the appliance.
- Penetrating moisture may cause an electric shock. Do not use any high pressure cleaners or steam cleaners.



### WARNING

**Ensure that the appliance is switched off before replacing the lamp to avoid the possibility of electric shock.**

#### Risk of burns!

- During use the appliance becomes hot. Care should be taken to avoid touching heating elements inside the oven.
- Accessories and ovenware become very hot. Always use oven gloves to remove accessories or ovenware from the cooking compartment.

- Alcoholic vapours may catch fire in the hot cooking compartment. Never prepare food containing large quantities of drinks with a high alcohol content.
- Foods with peel or skin may burst or explode during, or even after, heating. Never cook eggs in their shells or reheat hard-boiled eggs. Never cook shellfish or crustaceans. Always prick the yoke when baking or poaching eggs. The skin of foods that have a peel or skin, such as apples, tomatoes, potatoes and sausages, may burst. Before heating, prick the peel or skin.
- The contents of feeding bottles and baby food jars shall be stirred or shaken and the temperature checked before consumption, in order to avoid burns.
- Heated food gives off heat. The ovenware may become hot. Always use oven gloves to remove ovenware or accessories from the cooking compartment.

#### Risk of scalding!

- When you open the appliance door, hot steam may escape. Open the appliance door with care. Keep children at a safe distance.

#### Risk of injury!

- Unsuitable ovenware may crack. Porcelain or ceramic ovenware can have small perforations in the handles or lids. These perforations conceal a cavity below. Any moisture that penetrates this cavity could cause the ovenware to crack. Only use microwave-safe ovenware.



### CAUTION

**In order to avoid a hazard due to inadvertent resetting of the thermal cut-out, this appliance must not be supplied through an external switching device, such as a timer, or connected to a circuit that is regularly switched on and off by the utility**

## GENERAL CAUTIONS

### Causes of damage



### CAUTION

- Metal - e.g. a spoon in a glass - must be kept at least 2cm from the oven walls and the inside of the door. Sparks could irreparably damage the glass on the inside of the door.  
*NOTE: The wire grill racks supplied with this appliance are compatible for use on microwave mode. Please ensure only the supplied wire grill racks are used, and they must be placed centrally on the turntable during use.*
- Never pour water into the hot cooking compartment. This will cause steam. The temperature change can cause damage.
- Do not store moist food in the closed cooking compartment for long periods. Do not use the appliance to store food. This can lead to corrosion.
- Only allow the cooking compartment to cool with the door closed. Do not trap anything in the appliance door. Even if the door is only slightly ajar, the fronts of adjacent units may be damaged over time.
- If the seal is very dirty, the appliance door will no longer close properly during operation. The fronts of adjacent units could be damaged. Always keep the seal clean.
- Operating the appliance without food in the cooking compartment may lead to overloading. Never switch on the appliance unless there is food in the cooking compartment. An exception to this rule is a short crockery test (see the section "Microwave, suitable crockery").
- Do not stand or place anything on the open appliance door. Do not place ovenware or accessories on the appliance door.
- Do not carry or hold the appliance by the door handle. The door handle cannot support the weight of the appliance and could break.
- Liquid that has boiled over must not be allowed to run through the turntable drive into the interior of the appliance. Monitor the cooking process. Choose a shorter cooking time initially, and increase the cooking time as required.
- The oven should be cleaned regularly and any food deposits removed since it will reduce the efficiency of the microwave.
- Failure to maintain the oven in a clean condition could lead to deterioration of the surface that could adversely affect the life of the appliance and possibly result in a hazardous situation.

## INSTALLATION

### Fitted units

- This appliance is only intended to be fully built in to a kitchen.
- This appliance must not be installed behind a decorative door in order to avoid overheating
- This appliance is not designed to be used as a tabletop appliance or inside a cupboard.
- The fitted cabinet must not have a back wall behind the appliance.
- A gap of at least 45mm must be maintained between the wall and the base or back panel of the unit above.
- The fitted cabinet must have a ventilation opening of 250 cm<sup>2</sup> on the front. To achieve this, cut back the base panel or fit a ventilation grille.
- Ventilation slots and intakes must not be covered.
- The safe operation of this appliance can only be guaranteed if it has been installed in accordance with these installation instructions.
- The fitter is liable for any damage resulting from incorrect installation.
- The cabinetry into which the appliance is fitted must be heat resistant up to 90°C.
- If the appliance is installed on a base, measures must be taken to prevent the appliance from slipping from the base.



# PRODUCT DESCRIPTION

Use this section to familiarise yourself with your new appliance.

The control panel and the individual operating controls are explained. You will find information on the cooking compartment and the accessories.

## CONTROL PANEL



### Touch keys and display

The touch keys are used to set the various additional functions. On the display, you can read the values that you have set.

Symbol	Function
< FUNCTION >	Function selector
- +	Parameter adjustment
[<>]	Select parameter
[Clock]	Clock
[Diamond with 3s]	Touch and hold: Childproof Lock Touch briefly: Stop Touch twice: Cancel
[Diamond]	Start
[Auto Cook]	Auto-cook programs
[Defrost]	Defrost
[Lightning bolt]	Touch briefly: Rapid preheating

### Function selector

Use the function selector to set the type of heating.

Function	Use
[Hot air]	For baking sponge cakes in baking tins, flans and cheesecakes as well as cakes, pizza and small baked items on the baking tray. 50°C can be used to keep cooked food warm for 1-2 hours.
[Grill with fan]	Poultry goes brown and crispy. Baked casseroles and grilled dishes work out best using this setting.

[Pizza setting]	For frozen convenience products and dishes which require a lot of heat from underneath.
[Grill]	Select between the levels high, medium or low. This is ideal if you wish to grill several steaks, sausages, pieces of fish or slices of bread.
[Microwave+Hot air]	Use this function to roast meals quickly. And at the same time use the function of Hot air.
[Microwave+Grill Fan]	Poultry goes brown and crispy. Baked casseroles and grilled dishes work out best using this setting. You can also use this function to roast meals evenly.
[Microwave+Pizza]	Use this function to roast meals quickly. And at the same time use the function of Pizza setting.
[Microwave+Grill]	Use this function to cook meals quickly and at the same time give the meal a brown crust.
[Defrost]	2 defrosting programmes
[Auto-cook programs]	13 cooking programmes. The type of heating and cooking time are set by weight.
[Microwave]	Defrost, reheat and cooking.

### Parameter adjustment

Use the adjusting keys to set the parameters.

Parameter	Function
Auto menu	Select 13 automatic programmes. From P 01 to P 13.
Temperature	Select the temperature of cooking (°C). [Hot air]: 50, 100, 105, 110 ... 230 [Grill]: 100, 105, 110 ... 230 [Hot air+Grill]: 100, 105, 110 ... 230 [Hot air+Grill Fan]: 50, 100, 105, 110 ... 230 [Hot air+Grill Fan]: 100, 105, 110 ... 230 [Hot air+Grill Fan]: 100, 105, 110 ... 230
Weight	Set the weight of cooking.
Time	Set the time of cooking.
Microwave	Select microwave power. 100W, 300W, 450W, 700W and 900W

### Cooling fan

The appliance has a cooling fan that helps to vent the hot air and steam from inside the cavity. The cooling fan will continue to run for some time after the end of the cooking cycle has finished, this is part of the normal cooling cycle operation.

### CAUTION

**Do not cover the ventilation slots. Otherwise, the appliance will overheat.**

#### NOTE:

- Condensation may appear on the door window, interior walls and floor. This is normal and does not adversely affect microwave operation. Wipe away the condensation after cooking.

## ACCESSORIES

### Turntable

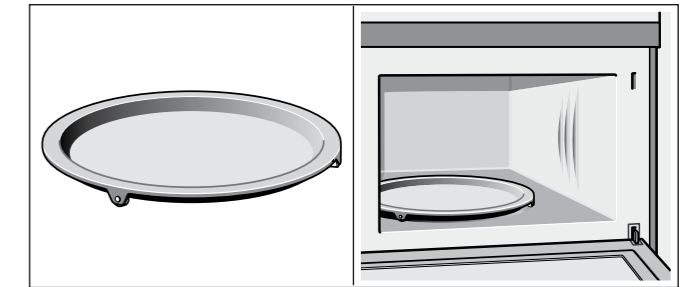

The supplied high and low wire racks are suitable for use with this product on all modes, including microwave mode. Please ensure that the wire grill rack is placed centrally on top of the turntable during use.

### WARNING

**Do not use other wire racks or metal cookware as they may not be compatible for use on microwave mode and could damage the appliance.**

Food which particularly requires a lot of heat from underneath can be prepared directly on the turntable.

The turntable can turn clockwise or anti-clockwise.

Place the turntable on the drive in the centre of the cooking compartment. Ensure that it is properly fitted.

- Never use the microwave without the turntable.
- The turntable can withstand max. 5 kg.
- The turntable must turn when using all types of heating.

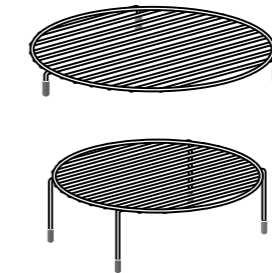

### Lower wire rack

For the microwave and for baking and roasting in the oven.

### Higher wire rack

For grilling, e.g. steaks, sausages and for toasting bread. As a support for shallow dishes.

### Cleaning the accessories

Before you use the accessories for the first time, clean them thoroughly with hot soapy water and a soft dish cloth.

## PRODUCT DESCRIPTION (CONTINUED)

### BEFORE USING THE APPLIANCE FOR THE FIRST TIME



Here you will find everything you need to do before using your oven to prepare food for the first time. First read the section on Safety information.

#### Setting the clock

Once the appliance is connected, "00:00" will blink, buzzer will ring once. Set the clock.





1. Touch "– +" key between 00:00 and 23:59
2. Touch the key . The time is set.

#### Changing the clock

1. Touch and hold the  key for 3 seconds in waiting state. The actual time disappear and then the time will blink in the display.
2. Touch "– +" key to set the new time and touch the  key to confirm the setting.

#### Heating up the oven

To remove the new cooker smell, heat up the oven when it is empty and closed. One hour with  at 230 °C is ideal. Ensure that no packaging remnants have been left in the cooking compartment.





1. Use the function selector to set  Hot air.
2. Touch the key  and then touch "– +" key to set the temperature to 230 °C.
3. Touch the key. Touch  key to set the cooking time to 60 minutes.
4. Touch the  key. The oven begins to heat up.

### SETTING THE OVEN

There are various ways in which you can set your oven. Here we will explain how you can select the desired type of heating and temperature or grill setting. You can also select the oven cooking time for your dish. Please refer to the section on Setting the time setting options .

#### Setting the type of heating and temperature



Example :  Hot air at 200 °C for 25 minutes.

1. Set the function selector to .
2. The default temperature 180 °C will light. Touch the  key. Touch "– +" key to set the temperature to 200 °C.
3. Touch the  key. Touch "– +" key to set the cooking time to 25 minutes.
4. Touch the  key. The oven begins to heat up.

#### Opening the oven door during operation

Operation is suspended. After closing the door, touch the  key. Operation continues.

#### Pausing operation

Touch the  key to pause operation. Then touch the  key to continue operation .

#### Changing the cooking time

This can be done at any time. Touch the  key . Touch "– +" key to change the cooking time.

#### Changing the temperature

This can be done at any time.

Touch the  for the new temperature setting. Touch "– +" key to set the temperature.





#### Cancelling operation

Touch the  key twice to cancel operation.



### RAPID PREHEATING

With rapid preheating, your oven reaches the set temperature particularly quickly .

Rapid Preheating is available for the following types of heating:

-  Hot air
-  Grill with fan
-  Microwave+Hot air
-  Microwave+Grill Fan
-  Pizza setting
-  Microwave+Pizza

To ensure an oven cooking result, only put your food in the cooking compartment when the preheating phase is complete.

1. Setting the type of heating and temperature .
2. Touch the  key. The  symbol lights up in the display.
3. Touch the  key.



The oven begins to heat up.

#### The preheating process is complete

A signal sounds. The  symbol in the display blinks. Put your dish in the oven.

#### Cancelling rapid preheating

During setting the rapid preheating function, touch the  can cancel the function.

During rapid preheating, touch the  or  can cancel the function. Also you can open the door to cancel the function.

#### NOTE:

1. *The rapid preheating function only works if you have already chosen one of the modes above. During preheating, the microwave function is switched off.*
2. *Only when you can hear alarm and preheating icon is blinking you can open the door and put food inside.*

## DAILY USE

Microwaves are converted to heat in foodstuffs. The microwave can be used solo, i.e. on its own, or in combination with a different type of heating. You will find information about ovenware and how to set the microwave.

*NOTE: In the Cooking Guide, you will find examples for defrosting, heating and cooking with the microwave oven.*

*NOTE: The time steps when adjusting the time vary depending on the total cooking time selected, the adjustment steps increase as the total cooking time increases as per below:*

0-1 min	:	1 second
1-5 min	:	10 seconds
5-15 min	:	30 seconds
15-60 min	:	1 minute
60 min	:	5 minutes

## OVENWARE

### Suitable ovenware

Suitable dishes are heat-resistant ovenware made of glass, glass ceramic, porcelain, ceramic or heat-resistant plastic. These materials allow microwaves to pass through.

You can also use serving dishes. This saves you having to transfer food from one dish to another. You should only use ovenware with decorative gold or silver trim if the manufacturer guarantees that they are suitable for use in microwaves.

### Unsuitable ovenware

Metal ovenware is unsuitable. Metal does not allow microwaves to pass through. Food in covered metal containers will remain cold.

*NOTE: The wire grill racks supplied with this appliance are compatible for use on microwave mode. Please ensure only the supplied wire grill racks are used, and they must be placed centrally on the turntable during use.*

### Ovenware test

Do not switch on the microwave unless there is food inside. The following ovenware test is the only exception to this rule.

Perform the following test if you are unsure whether your ovenware is suitable for use in the microwave :

1. Heat the empty ovenware at maximum power for 1/2 to 1 minute.
2. Check the temperature occasionally during that time.

The ovenware should still be cold or warm to the touch.

The ovenware is unsuitable if it becomes hot or sparks are generated.

## MICROWAVE POWER SETTINGS

Use the  key to set the desired microwave power.

100W	- Defrosting sensitive/delicate foods - Defrosting irregularly-shaped foods - Softening ice cream - Allowing dough to rise
300 W	- Defrosting - Melting chocolate and butter
450 W	- cooking rise, soup
700 W	- Reheating - cooking mushrooms, shell fish - cooking dishes containing eggs and cheese
900 W	- Boiling water, reheating - cooking chicken, fish, vegetables





*NOTE:*

- *When you touch a key, the selected power lights up.*
- *The microwave power can be set to 900 watts for a maximum of 30 minutes. With all other power settings a maximum cooking time of 1 hour 30 minutes is possible.*

## SETTING THE MICROWAVE

### Example:

Microwave power setting 300 W, cooking time 17 minutes

1. Set the function selector to . The default microwave power 900W will appear.
2. Touch the  key, the default cooking time will blink. Touch “- +” key to adjust the cooking time to 17 minutes.
3. Touch the  key. Touch “- +” key to adjust the microwave power to 300W.
4. Touch the  key. Operation begins. The cooking time starts counting down in the display.

### The cooking time has elapsed

A signal sounds. Microwave operation has finished.

### Opening the oven door during operation

Operation is suspended. After closing the door, touch the  key. Operation continues.



### Changing the cooking time

This can be done at any time. Touch the  key. Touch “- +” key to change the cooking time.

### Changing the microwave power setting

This can be done at any time. Touch the  for the new microwave power setting. Touch “- +” key to set the microwave power.

### Pausing operation

Touch the  key briefly. The oven is paused. Touch the  key again to continue operation.

### Cancelling operation

Touch the  key twice to cancel operation.

*NOTE:*

- *When you touch the  microwave key, the highest microwave power setting always lights up as the suggested setting.*
- *If you open the appliance door during cooking, the fan may continue to run.*







## MICROCOMBI OPERATION

This involves simultaneous operation of the grill and the microwave. Using the microwave makes your dishes ready more quickly, but they are still nicely browned.

You can switch on all microwave power settings.  
Exception: 900 watts

### Setting Microwave Combi operation

Example: microwave 100W, 17 minutes and hot air  190°C.

1. Set the function selector to +.
2. The default temperature 180°C will blink. Touch the  key. Touch “- +” key to set the temperature to 190 °C.
3. The default microwave power is 300W. Touch the  key again and then touch “- +” key to set the microwave power to 100W.
4. Touch the  key. Touch “- +” key to set the cooking time to 17 minutes.
5. Touch the  key.

Appliance operation begins. The cooking time starts counting down.



### The cooking time has elapsed

A signal sounds. Combination mode has finished.

### Opening the oven door during cooking

Operation is suspended. After closing the door, touch the  key briefly. The programme will then continue.

### Pausing operation

Touch the  key briefly. The oven is paused. Touch the  key again to continue operation.

### Changing the cooking time

This can be done at any time. Touch the  key. Touch “- +” key to change the cooking time.

### Changing the microwave power setting

This can be done at any time.  
Touch the  for the new microwave power setting.  
Touch “- +” key to set the microwave power.

### Changing the temperature

This can be done at any time.  
Touch the  for the new temperature setting.  
Touch “- +” key to set the temperature.

### Cancelling operation

Touch the  key twice to cancel operation.

## AUTOMATIC PROGRAMMES





The automatic programmes enable you to prepare food very easily. You select the programme and enter the weight of your food. The automatic programme makes the optimum setting. You can choose from 13 programmes.

Always place the food in the cold cooking compartment.

### Setting a programme

When you have selected a programme, set the oven. The temperature selector must be in the off position.

Example: Programme 3 with a weight of 1 kilogramme.

1. Touch the  key.  
The first programme number appears in the display.
2. Touch “- +” or  key to select the programme number PO3.
3. Touch the  key.
4. Touch “- +” key to set the weight, cooking time will shown.
5. Touch the  key. The programme starts. You can see the cooking time counting down .

## AUTO MENU

Programme no.	Category	Item
P 01**	Vegetables	Fresh vegetables
P 02**	Side dishes	Potatoes-peeled / cooked
P 03*	Side dishes	Potatoes-roasted <small>If you hear a beep,turn the food. The combi microwave oven starts the next phase automatically.</small>
P 04	Poultry/Fish	Chicken pieces <small>If you hear a beep,turn the food .The combi microwave oven starts the next phase automatically .</small>
P 05*	Bakery	Cake
P 06*	Bakery	Apple pie
P 07*	Bakery	Quiche
P 08**	Reheat	Drink/soup

P 09**	Reheat	Plated meal
P 1 0**	Reheat	Sauce/stew/dish
P 11 *	Convenience	Frozen - Pizza
P 12*	Convenience	Frozen - Oven chips <small>If you hear a beep,turn the food. The combi microwave oven starts the next phase automatically.</small>
P 13*	Convenience	Frozen - Lasagna

### NOTE:

- *The programmes with a \* are preheated. During preheating, the cooking time pauses and the preheating symbol is on. After preheating, you will hear an alarm and the preheating symbol will blink.*
- *The programmes with \*\* only use the microwave function.*

### Programme has ended

A signal sounds. The oven stops heating.

### Changing the programme

Once you have started the programme, the programme number and weight cannot be changed.

### Cancelling the programme

Touch the  key twice to cancel operation.





### Changing the cooking time

If using automatic programmes, you cannot change the cooking time.



## DEFROSTING PROGRAMMES

You can use the 2 defrosting programmes to defrost meat, poultry and bread .

1. Touch the  key.  
The first programme number appears in the display.
2. Touch “- +” or  key to select the programme number .
3. Touch the  key.
4. Touch “- +” key to set the weight, cooking time will shown.
5. Touch the  key. The programme starts.  
You can see the cooking time counting down .

*NOTE:*

- **Preparing food**

Use food that has been frozen at -18°C and stored in portion sized quantities that are as thin as possible. Take the food to be defrosted out of all packaging and weigh it. You need to know the weight to set the programme.

- Liquid will be produced when defrosting meat or poultry. Drain off this liquid when turning meat and poultry and under no circumstances use it for other purposes or allow it to come into contact with other foods.

- **Ovenware**

Place the food in a microwaveable shallow dish, e.g. a china or glass plate , but do not cover.

- When defrosting chicken and chicken portions (d 01), an audible signal will sound on two occasions to indicate that the food should be turned.

- **Resting time**

The defrosted food should be left to stand for an additional 10 to 30 minutes until it reaches an even temperature. Large pieces of meat require a longer standing time than smaller pieces. Flat pieces of meat and items made from minced meat should be separated from each other before leaving to stand.

After this time, you can continue to prepare the food, even though thick pieces of meat may still be frozen in the middle. The giblets can be removed from poultry at this point.

Programme no.	Defrost	Weight range in kg
D 01*	meat, poultry and fish	0.20 - 1.00
D 02*	bread, cake and fruit	0.10 - 0.50

\*During defrosting, place the food on the lower wire rack.

## TIME-SETTING OPTIONS

Your oven has various time-setting options. You can use the  key to call up the menu and switch between the individual functions. A time-setting option that has already been set can be changed directly with the “- +” key.

### Setting the cooking time

The cooking time for your meal can be set on the oven. When the cooking time has elapsed, the oven switches itself off automatically. This means that you do not have to interrupt other work to switch off the oven. The cooking time cannot be accidentally exceeded.

The oven starts. The cooking time counts down in the display.

### The cooking time has elapsed

An audible signal sounds. The oven stops heating.

## CHILDPROOF LOCK

The oven has a childproof lock to prevent children switching it on accidentally.

The oven will not react to any settings. The timer and clock can also be set when the childproof lock has been switched on.

### Switching on the childproof lock

Requirement: No cooking time should be set .

Touch and hold the  key for approx. 3 seconds.

The  symbol appears in the display. The childproof lock is activated.

### Switching off the childproof lock

Touch and hold the  key for approx. 3 seconds.

The  symbol on the display goes out. The childproof lock is deactivated.

### Childproof lock with other cooking operations

When other cooking programmes have been set, the childproof lock is not operational.



## COOKING GUIDE

Here you will find a selection of recipes and the ideal settings for them. We will show you which type of heating and which temperature or microwave power setting is best for your meal.

You can find information about suitable accessories and the height at which they should be inserted. There are also tips about ovenware and preparation methods.

- The values in the table always apply to food placed into the cooking compartment when it is cold and empty. Only preheat the appliance if the table specifies that you should do so. Before using the appliance, remove all accessories from the cooking compartment that you will not be using.
- Do not line the accessories with greaseproof paper until after they have been preheated.
- The times specified in the tables are only guidelines. They will depend on the quality and composition of the food.
- Use the accessories supplied. Additional accessories may be obtained from specialist retailers or from the after-sales service.
- Always use an oven cloth or oven gloves when taking accessories or ovenware out of the cooking compartment.

### DEFROSTING, HEATING UP AND COOKING WITH THE MICROWAVE

The following tables provide you with numerous options and settings for the microwave .

The times specified in the tables are only guidelines. They may vary according to the ovenware used, the quality, temperature and consistency of the food.

Time ranges are often specified in the tables. Set the shortest time first and then extend the time if necessary.

It may be that you have different quantities from those specified in the tables. A rule of thumb can be applied: Double amount - just under double the cooking time, half amount - half the cooking time.

#### Defrosting

- Place the frozen food in an open container on the lower wire rack.
- Delicate parts such as the legs and wings of chicken or fatty outer layers of roasts can be covered with small pieces of aluminium foil. The foil must not touch the cooking compartment walls. You can remove the foil half way through the defrosting time.
- Turn or stir the food once or twice during the defrosting time. Large pieces of food should be turned several times. When turning, remove any liquid that has resulted from defrosting.
- Leave defrosted items to stand at room temperature for a further 10 to 60 minutes so that the temperature can stabilise. The giblets can be removed from poultry at this point.

Defrost	Weight	Microwave power setting in watts, cooking time in minutes	Notes
Whole pieces of meat (beef, veal or pork - on the bone or boned)	800 g	300 W, 15 mins + 100 W, 10-20 mins	Turn several times
	1 kg	300 W, 20 mins + 100 W, 15-25 mins	
	1.5 kg	300 W, 30 mins + 100 W, 20-30 mins	
Meat in pieces or slices of beef, veal or pork	200 g	300 W, 3 mins + 100 W, 10-15 mins	Separate any defrosted parts when turning
	500 g	300 W, 5 mins + 100 W, 15-20 mins	
	800 g	300 W, 8 mins + 100 W, 15-20 mins	
Minced meat, mixed	200 g	100 W, 10-15 mins	Freeze food flat if possible Turn several times, remove any defrosted meat
	500 g	300 W, 5 mins + 100 W, 10-15 mins	
	800 g	300 W, 8 mins + 100 W, 15-20 mins	
Poultry or poultry portions	600 g	300 W, 8 mins + 100 W, 10-15 mins	Turn during cooking
	1.2 kg	300 W, 15 mins + 100 W, 25-30 mins	
Duck	2 kg	300 W, 20 mins + 100 W, 30-40 mins	Turn several times
Fish fillet, fish steak or slices	400 g	300 W, 5 mins + 100 W, 10-15 mins	Separate any defrosted parts
Whole fish	300 g	300 W, 3 mins + 100 W, 10-15 mins	-
	600 g	300 W, 8 mins + 100 W, 10-15 mins	
Vegetables, e.g. peas	300 g	300 W, 10-15 mins	Stir carefully during defrosting.
	600 g	300 W, 10 mins + 100 W, 10-15 mins	
Fruit, e.g. raspberries	300 g	300 W, 7-10 mins	Stir carefully during defrosting and separate any defrosted parts
	500 g	300 W, 8 mins + 100 W, 5-10 mins	
Butter, defrosting	125 g	300 W, 1 mins + 100 W, 2-4 mins	Remove all packaging
	250 g	300 W, 1 min + 100 W, 2-4 mins	
Loaf of bread	500 g	300 W, 6 mins + 100 W, 5-10 mins	Turn during cooking.
	1 kg	300 W, 12 mins + 100 W, 15-25 mins	
Cakes, dry, e.g. sponge cake	500 g	100 W, 15-20 mins	Only for cakes without icing, cream or crème pâtissière, separate the pieces of cake.
	750 g	300 W, 5 mins + 100 W, 10-15 mins	
Cakes, moist, e.g. fruit flan, cheesecake	500 g	300 W, 5 mins + 100 W, 10-15 mins	Only for cakes without icing, cream or gelatine
	750 g	300 W, 7 mins + 100 W, 10-15 mins	

- Place the food directly on the turntable.

## COOKING GUIDE (CONTINUED)

### DEFROSTING, HEATING UP OR COOKING FROZEN FOOD

- Take ready meals out of the packaging. They will heat up more quickly and evenly in microwaveable ovenware. The different components of the meal may not require the same amount of time to heat up .
- Food which lies flat will cook more quickly than food which is piled high. You should therefore distribute the food so that it is as flat as possible in the ovenware. Different foodstuffs should not be placed in layers on top of one another.
- Always cover the food. If you do not have a suitable cover for your ovenware, use a plate or special microwave foil.
- Stir or turn the food 2 or 3 times during cooking.
- After heating, allow the food to stand for a further 2 to 5 minutes so that it can achieve an even temperature.
- Always use an oven cloth or oven gloves when removing plates from the oven.
- This will help the food retain its own distinct taste, so it will require less seasoning.

Defrost	Weight	Microwave power setting in watts, cooking time in minutes	Notes
Menu, plated meal, ready meal	300-400 g	700 W, 10-15 mins	Take meal out of packaging; cover food to heat
Soup	400-500 g	700 W, 8-10 mins	Ovenware with lid
Stews	500 g	700 W, 10-15 mins	Ovenware with lid
	1 kg	700 W, 20-25 mins	
Slices or pieces of meat in sauce, e.g. goulash	500 g	700 W, 15-20 mins	Ovenware with lid
	1 kg	700 W, 25-30 mins	
Fish, e.g. fillet steaks	400 g	700 W, 10-15 mins	Covered
	800 g	700 W, 18-20 mins	
Side dishes, e.g. rice, pasta	250 g	700 W, 2-5 mins	Ovenware with lid; add liquid
	500 g	700 W, 8-10 mins	
Vegetables, e.g. peas, broccoli, carrots	300 g	700 W, 8-10 mins	Ovenware with lid; add 1 tbsp of water
	600 g	700 W, 15-20 mins	
Creamed spinach	450 g	700 W, 11-16 mins	Cook without additional water

### HEATING FOOD

**! WARNING**  
**Risk of scalding!**

There is a possibility of delayed boiling when a liquid is heated. This means that the liquid reaches boiling temperature without the usual steam bubbles rising to the surface. Even if the container only moves a little, the hot liquid can suddenly boil over and spatter. When heating liquids, always place a spoon in the container. This will prevent delayed boiling.

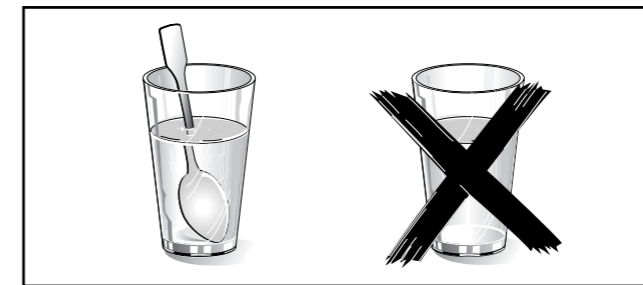

**! CAUTION**

**Metal - e.g. a spoon in a glass - must be kept at least 2 cm from the oven walls and the inside of the door. Sparks could irreparably damage the glass on the inside of the door.**

- Take ready meals out of the packaging. They will heat up more quickly and evenly in microwaveable ovenware. The different components of the meal may not require the same amount of time to heat up
- Always cover the food. If you do not have a suitable cover for your container, use a plate or special microwave foil.
- Stir or turn the food several times during the heating time. Check the temperature.
- After heating, allow the food to stand for a further 2 to 5 minutes so that it can achieve an even temperature.
- Always use an oven cloth or oven gloves when removing plates from the oven .
- Place the cookware with food directly on the turntable, or on the supplied wire grill racks..

Defrost	Weight	Microwave power setting in watts, cooking time in minutes	Notes
Menu, plated meal, ready meal	350-500 g	700 W, 5-10 mins	Take meal out of packaging, cover food to heat
Drinks	150 ml	900 W, 1-2 mins	Caution! Place a spoon in the glass. Do not overheat alcoholic drinks. Check during heating
	300 ml	900 W, 2-3 mins	
	500 ml	900 W, 3-4 mins	
Baby food, e.g. baby bottle	50 ml	300 W, approx. 1 min	Place baby bottles on the cooking compartment floor without the teat or lid. Shake or stir well after heating. You must check the temperature
	100 ml	300 W, 1-2 mins	
	200 ml	300 W, 2-3 mins	
Soup	175 g	900 W, 2-3 mins	-
1 cup			
2 cups	175 g each	900 W, 4-5 mins	
4 cups	175 g each	900 W, 5-6 mins	
Slices or pieces of meat in sauce, e.g. goulash	500 g	700 W, 10-15 mins	Covered
Stew	400 g	700 W, 5-10 mins	Ovenware with lid
	800 g	700 W, 10-15 mins	
Vegetables	150 g	700 W, 2-3 mins	Add a little liquid
	300 g	700 W, 3-5 mins	

## COOKING GUIDE (CONTINUED)

### COOKING FOOD

- Food which lies flat will cook more quickly than food which is piled high. You should therefore distribute the food so that it is as flat as possible in the ovenware. Different foodstuffs should not be placed in layers on top of one another.
- Place the food directly on the turntable.
- Cook the food in ovenware with a lid. If you do not have a suitable lid for your ovenware, use a plate or special microwave foil.
- This will help the food retain its own distinct taste, so it will require less seasoning.
- After cooking, allow the food to stand for a further 2 to 5 minutes so that it can achieve an even temperature.
- Always use an oven cloth or oven gloves when removing plates from the oven.

Defrost	Weight	Microwave power setting in watts, cooking time in minutes	Notes
Whole chicken, fresh, no giblets	1.5 kg	700 W, 30-35 mins	Turn halfway through the cooking time
Fish fillet, fresh	400 g	700 W, 5-10 mins	-
Fresh vegetables	250 g	700 W, 5-10 mins	Cut into equal-sized pieces; add 1 to 2 tbsp water per 100 g; stir during cooking
	500 g	700 W, 10-15 mins	
Potatoes	250 g	700 W, 8-10 mins	Cut into equal-sized pieces; add 1 to 2 tbsp water per 100 g; stir during cooking
	500 g	700 W, 11-14 mins	
	750 g	700 W, 15-22 mins	
Rice	125 g	700 W, 7-9 mins+ 300 W, 15-20 mins	Add double the quantity of liquid and use deep ovenware with a lid
	250 g	700 W, 10-12 mins + 300 W, 20-25 mins	
Sweet foods , e.g. blancmange (instant)	500 ml	700 W, 7-9 mins	Stir 2 to 3 times with an egg whisk while heating
Fruit, compote	500 g	700 W, 9-12 mins	-

### POPCORN FOR THE MICROWAVE

- Use heat-resistant, flat glass ovenware , e.g. the lid of an ovenproof dish, a glass plate or a glass tray (Pyrex)
- Always place the ovenware on the supplier wire rack.
- Do not use porcelain or overly curved plates.
- Make the settings as described in the table. You can adjust the timings according to product and amount.
- So that the popcorn doesn't burn, briefly take the popcorn bag out of the oven after 1 minute and 30 seconds and shake it. Take care as the bag will be hot!



#### WARNING

#### Risk of scalding!

- Open the popcorn bag carefully as hot steam may be released.
- Never set the microwave to full power.

	Weight	Accessories	Microwave power in watts, Cooking time in minutes
Popcorn for the microwave	1 bag, 100 g	Ovenware	700 W, 3-5 mins

### MICROWAVE TIPS

If you cannot find any information about the settings for the quantity of food you have prepared.	Increase or reduce the cooking times using the following rule of thumb: Double the amount = almost double the cooking time Half the amount = half the cooking time
If the food has become too dry.	Next time, set a shorter cooking time or select a lower microwave power setting. Cover the food and add more liquid.
When the time has elapsed, the food is not defrosted, hot or cooked.	Set a longer time. Large quantities and food which is piled high require longer times.
When the time has elapsed, the food is overheated at the edge but not done in the middle.	Stir it during the cooking time and next time, select a lower microwave power setting and a longer cooking time.
After defrosting , the poultry or meat is defrosted on the outside but not defrosted in the middle.	Next time, select a lower microwave power setting. If you are defrosting a large quantity, turn it several times.

### CAKES AND PASTRIES

#### About the tables

- The times given apply to food placed in a cold oven.
- The temperature and baking time depend on the consistency and amount of the mixture. This is why temperature ranges are given in the tables. Begin with the lower temperature and, if necessary, use a higher setting the next time, since a lower temperature results in more even browning.
- Additional information can be found in the Baking tips section following the tables.
- Always place the cake tin in the centre of the lower wire rack. But the food with \*\* should be placed in the turntable.**

#### Baking tins

NOTE: It is best to use dark-coloured metal baking tins.





Baking in tins	Accessories	Type of heating	Temperature °C	Microwave power in watts	Cooking time in minutes
Sponge cake, simple	Ring tin/cake tin		170-180	100	40-50
Sponge cake, delicate (e.g. sandcake)*	Ring tin/cake tin		150-170	-	70-90
Sponge flan base	Flan-base cake tin		160-180	-	30-40
Delicate fruit flan, sponge	Springform/ring tin		170-180	100	35-45
Sponge base, 2 eggs	Flan-base cake tin		160-170	-	20-25
Sponge flan, 6 eggs	Dark springform cake tin		170-180	-	35-45
Shortcrust pastry base with crust	Dark springform cake tin		170-190	-	30-40
Fruit tart/cheesecake with pastry base*	Dark springform cake tin		170-190	100	35-45
Swiss flan**	Dark springform cake tin		190-200	-	45-55
Ring cake	Ring cake tin		170-180	-	40-50
Pizza, thin base, light topping**	Round pizza tray		220-230	-	15-25
Savoury cakes**	Dark springform cake tin		200-220	-	50-60
Nut cake	Dark springform cake tin		170-180	100	35-45
Yeast dough with dry topping	Round pizza tray		160-180	-	50-60

\* Allow cake to cool in the oven for approx. 20 minutes







\*\* The food should be placed in the turntable







## COOKING GUIDE (CONTINUED)

Baking in tins	Accessories	Type of heating	Temperature °C	Microwave power in watts	Cooking time in minutes
Yeast dough with moist topping	Round pizza tray		170-190	-	55-65
Plaited loaf with 500 g flour	Round pizza tray		170-190	-	35-45
Stollen with 500 g flour	Round pizza tray		160-180	-	60-70
Strudel, sweet	Round pizza tray		190-210	100	35-45

\* Allow cake to cool in the oven for approx. 20 minutes

Small baked items	Accessories	Type of heating	Temperature °C	Cooking time in minutes
Biscuits	Round pizza tray		150-170	25-35
Macaroons	Round pizza tray		110-130	35-45
Meringue	Round pizza tray		100	80-100
Muffins	Muffin tray on wire rack		160-180	35-40
Choux pastry	Round pizza tray		200-220	35-45
Puff pastry	Round pizza tray		190-200	35-45
Leavened cake	Round pizza tray		200-220	25-35

Bread and bread rolls	Accessories	Type of heating	Temperature °C	Cooking time in minutes
Sourdough bread with 1 .2 kg flour	Round pizza tray		150-170	25-35
Flatbread	Round pizza tray		110-130	35-45
Bread rolls	Round pizza tray		100	80-100
Rolls made with sweet yeast dough	Muffin tray on wire rack		160-180	35-40

### BAKING TIPS

You want to bake according to your own recipe.	Use similar items in the baking tables as a guide.
Use baking tins made of silicone, glass, plastic or ceramic materials.	The baking tin must be heat-resistant up to 250 °C. Cakes in these baking tins will be less brown. When using the microwave, the cooking time will be shorter than the time shown in the table.
How to establish whether sponge cake is baked through.	Approximately 10 minutes before the end of the baking time specified in the recipe, poke the cake with a cocktail stick at its highest point. If the cocktail stick comes out clean, the cake is ready.
The cake collapses.	Use less liquid next time or set the oven temperature 10 degrees lower and extend the baking time. Observe the specified mixing times in the recipe.
The cake has risen in the middle but is lower around the edge.	Only grease the base of the springform cake tin. After baking, loosen the cake carefully with a knife.
The cake is too dark.	Select a lower temperature and bake the cake for a little longer.

The cake is too dry.	When it is done, make small holes in the cake using a toothpick. Then drizzle fruit juice or an alcoholic beverage over it. Next time, select a temperature 10 degrees higher and reduce the baking time.
The bread or cake (e.g. cheesecake) looks good, but is soggy on the inside (sticky, streaked with water).	Use slightly less fluid next time and bake for slightly longer at a lower temperature. When baking cakes with a moist topping, bake the base first, cover with almonds or bread crumbs and then add the topping. Please follow the recipe and follow the baking times.
The cake cannot be turned out of the dish when it is turned upside down.	After baking, allow the cake to cool for a further 5 to 10 minutes, then it will be easier to turn out of the tin. If it still sticks, carefully loosen the cake around the edges using a knife. Turn the cake tin upside down again and cover it several times with a cold, wet cloth. Next time, grease the tin well and sprinkle some bread crumbs into it.
You have measured the temperature of the oven using your own meat thermometer and found there is a discrepancy.	The oven temperature is measured by the manufacturer after a specified period of time using a test rack in the centre of the cooking compartment. Ovenware and accessories affect the temperature measurement, so there will always be some discrepancy when you measure the temperature yourself.
Sparks are generated between the tin and the wire rack.	Check that the tin is clean on the outside. Change the position of the tin in the cooking compartment. If this does not help, continue baking but without the microwave. The baking time will then be longer.

### ROASTING AND GRILLING

#### About the tables

The temperature and roasting time depend on the type and amount of food being cooked. This is why temperature ranges are given in the tables. Begin with the lower temperature and, if necessary, use a higher setting the next time,

For more information, see the section entitled Tips for grilling and roasting which follows the tables.

#### Ovenware

You may use any heat resistant ovenware which is suitable for use in a microwave. Metal roasting dishes are not suitable for roasting with microwaves.

The ovenware can become very hot. Use oven gloves to take the ovenware out of the oven.

Place hot glass ovenware on a dry kitchen towel after they have been removed from the oven. The glass could crack if placed on a cold or wet surface.

#### Tips for roasting

- Use a deep roasting dish for roasting meat and poultry.
- Check that your ovenware fits in the cooking compartment. It should not be too big.
- Meat: Cover approx. two thirds of the ovenware base with liquid. Add slightly more liquid for pot roasts. Turn pieces of meat halfway through the cooking time. When the roast is ready, turn off the oven and allow it to rest for an additional 10 minutes. This allows better distribution of the meat juices.
- Poultry: Turn the pieces of meat after  $\frac{2}{3}$  of the cooking time has elapsed.

#### Tips for grilling





- Always keep the oven door closed when grilling and do not preheat.
- As far as possible, the pieces of food you are grilling should be of equal thickness. Steaks should be at least 2 to 3 cm thick. This will allow them to brown evenly and remain succulent and juicy. Do not add salt to steaks until they have been grilled.
- Use tongs to turn the pieces of food you are grilling. If you pierce the meat with a fork, the juices will run out and it will become dry.
- Dark meat, e.g. beef, browns more quickly than lighter coloured meat such as veal or pork. When grilling light-coloured meat or fish, these often only brown slightly on the surface, although they are cooked and juicy on the inside.
- The grill element switches off and on again automatically. This is normal. The grill setting determines how frequently this will happen.



## COOKING GUIDE (CONTINUED)

### Beef



- Turn pot-roasted beef after  $\frac{1}{3}$  and  $\frac{2}{3}$  of the cooking time. Finally, allow to stand for approx. a further 10 minutes.
- Turn tenderloins and sirloins halfway through the cooking time. Finally, allow to stand for approx. a further 10 minutes.
- Turn steaks after  $\frac{2}{3}$  of the cooking time.

Beef	Accessories	Type of heating	Temperature °C, grill setting	Microwave power in watts	Cooking time in minutes
Pot-roasted beef, approx. 1 kg	Ovenware with lid		180-200	-	120-143
Fillet of beef, medium, approx. 1 kg*	Ovenware without lid		180-200	100	30-40
Sirloin, medium, approx. 1 kg*	Ovenware without lid		210-230	100	30-40
Steak, medium, 3 cm thick**	Higher wire rack		3	-	each side: 10-15

\* Lower wire rack \*\* Higher wire rack

### Veal





- Turn joints and knuckle of veal halfway through the cooking time. Finally, allow to stand for approx. a further 10 minutes.

Veal	Accessories	Type of heating	Temperature °C	Microwave power in watts	Cooking time in minutes
Joint of veal, approx. 1 kg*	Ovenware with lid		180-200	-	110-130
Knuckle of veal, approx. 1.5 kg*	Ovenware with lid		200-220	-	120-130

\*Lower wire rack

### Pork



- Turn lean joints of pork and rindless joints halfway through the cooking time. Finally, allow to stand for approx. a further 10 minutes.
- Place the joint in the ovenware rind-side up. Score the rind. Do not turn the joint. Finally, allow to stand for approx. a further 10 minutes.

Pork	Accessories	Type of heating	Temperature °C, grill setting	Microwave power in watts	Cooking time in minutes
Joint without rind, (e.g. neck), approx. 750 g*	Ovenware with lid		220-230	100	40-50
Joint with rind (e.g. shoulder) approx. 1.5 kg*	Ovenware without lid		190-210	-	130-150
Fillet of pork, approx. 500 g*	Ovenware with lid		220-230	100	25-30
Joint of pork, lean, approx. 1 kg*	Ovenware with lid		210-230	100	60-80
Smoked pork on the bone, approx. 1 kg*	Ovenware without lid	-	-	300	45-50
Neck of pork, 2 cm thick**			3	-	1st side: approx. 15-20 2nd side: approx. 10-15

\* Lower wire rack \*\* Higher wire rack

### Lamb



- Turn the leg of lamb halfway through the cooking time.

Lamb	Accessories	Type of heating	Temperature °C	Microwave power in watts	Cooking time in minutes
Saddle of lamb on the bone, approx. 1 kg*	Ovenware without lid		210-230	-	40-50
Leg of lamb, boned, medium, approx. 1.5 kg*	Ovenware with lid		190-210	-	90-95

\* Lower wire rack

### Miscellaneous

- Finally, allow the meat loaf to stand for approx. a further 10 minutes.
- Turn the sausages after  $\frac{2}{3}$  of the cooking time.

Miscellaneous	Accessories	Type of heating	Temperature °C, grill setting	Microwave power in watts	Cooking time in minutes
Meat loaf, approx. 1 kg*	Ovenware without lid		180-200	700 W + 100 W	-
4 to 6 sausages for grilling approx. 150 g each**	-		3	-	each side: 10-15

\* Lower wire rack \*\* Higher wire rack

## COOKING GUIDE (CONTINUED)

### Poultry

- Place whole chickens and chicken breasts breast-side down. Turn after  $\frac{2}{3}$  of the cooking time.
- Place poulard breast-side down. Turn after 30 minutes and set the microwave power to 180 watts.
- Place half chickens and chicken portions skin-side up. Do not turn.
- Turn the duck and goose breast skin-side up. Do not turn.
- Turn goose thighs halfway through the cooking time. Prick the skin.
- Place turkey breast and thighs skin-side down. Turn after  $\frac{2}{3}$  of the cooking time.

Poultry	Accessories	Type of heating	Temperature °C, grill setting	Microwave power in watts	Cooking time in minutes
Chicken, whole, approx. 1.2 kg*	Ovenware with lid		220-230	300	35-45
Poulard, whole, approx. 1.6 kg*	Ovenware with lid		220-230	300 100	30 20-30
Chicken, halves, 500 g each*	Ovenware without lid		180-200	300	30-35
Chicken portions, approx. 800 g*	Ovenware without lid		210-230	300	20-30
Chicken breast with skin and bones, 2 pieces, approx. 350-450 g*	Ovenware without lid		190-210	100	30-40
Duck breast with skin, 2 pieces, 300-400 g each**	Ovenware without lid		3	100	20-30
Goose breast, 2 pieces, 500 g each*	Ovenware without lid		210-230	100	25-30
Goose legs, 4 pieces, approx. 1.5 kg*	Ovenware without lid		210-230	100	30-40
Turkey breast, approx. 1 kg*	Ovenware with lid		200-220	-	90-100
Turkey drumsticks, approx. 1.3 kg*	Ovenware with lid		200-220	100	50-60

\* Lower wire rack \*\* Higher wire rack

### Fish

- For grilling, place the whole fish, e.g. trout, onto the middle of the higher wire rack.
- Grease the wire rack with oil beforehand.

Fish	Accessories	Type of heating	Grill setting	Cooking time in minutes
Fish steak, e.g. salmon, 3 cm thick, grilled	Higher wire rack		3	20-25
Whole fish, 23 pieces, 300 g each, grilled	Higher wire rack		3	20-30

### TIPS FOR ROASTING AND GRILLING

The table does not contain information for the weight of the joint.	For small roasts, select a higher temperature and a shorter cooking time. For larger roasts, select a lower temperature and a longer cooking time.
How to tell when the roast is ready.	Use a meat thermometer (available from specialist shops) or carry out a "spoon test". Press down on the roast with a spoon. If it feels firm, it is ready. If the spoon can be pressed in, it needs to be cooked for a little longer.
The roast looks good but the juices are burnt.	Next time, use a smaller roasting dish or add more liquid.
The roast looks good but the juices are too clear and watery.	Next time, use a larger roasting dish and add less liquid.
The roast is not well-done enough.	Carve the roast. Prepare the gravy in the roasting dish and place the slices of roast meat in the gravy. Finish cooking the meat using the microwave only.

### BAKES, GRATINS, TOAST WITH TOPPINGS

- The values in the table apply to food placed in a cold oven.
- For bakes, potato gratins and lasagne, use a microwaveable, heat-resistant ovenproof dish 4 to 5cm deep
- Place the bake on the lower wire rack.
- Leave bakes and gratins to cook in the oven for a further 5 minutes after switching off.
- Cheese on toast: Pretoast slices of bread.

Bakes, gratins, toasts	Accessories	Type of heating	Temperature °C, grill setting	Microwave power in watts	Cooking time in minutes
Bake, sweet, approx. 1.5 kg*	Ovenware without lid		140-160	300	25-35
Savoury bake, made with cooked ingredients, approx. 1 kg*	Ovenware without lid		150-160	700	20-25
Lasagne, fresh*	Ovenware without lid		200-220	300	25-35
Potato gratin made from raw ingredients, approx. 1.1 kg*	Ovenware without lid		180-200	700	25-30
Toast with topping, 4 slices**	-		3	-	8-10

\* Lower wire rack \*\* Higher wire rack

## COOKING GUIDE (CONTINUED)

### CONVENIENCE PRODUCTS, FROZEN

- Observe the instructions on the packaging.
- The values in the table apply to food placed in a cold oven.
- Do not lay chips, croquettes or potato röstis on top of each other. Turn half way through the cooking time.
- Place the food directly on the turntable.

Convenience products	Accessories	Type of heating	Temperature °C	Microwave power in watts	Cooking time in minutes
Pizza with thin base*	Turntable		220-230	-	10-15
Pizza with deep-pan base	Turntable		-	700	3
			220-230	-	13-18
Mini pizza*	Turntable		220-230	-	10-15
Pizza baguette*	Turntable		-	700	2
			220-230	-	13-18
Chips	Turntable		220-230	-	8-13
Croquettes*	Turntable		210-230	-	13-18
Rösti, stuffed potato pockets	Turntable		200-220	-	25-30
Part-cooked rolls or baguette	Lower wire rack		170-180	-	13-18
Fish fingers	Turntable		210-230	-	10-20
Chicken goujons, nuggets	Turntable		200-220	-	15-20
Lasagne, approx. 400 g**	Lower wire rack		220-230	700	12-17

\* Preheat the cooking compartment for 5 minutes.

\*\* Place the food in suitable, heat-resistant ovenware.

## CARE AND CLEANING

With careful care and cleaning your microwave oven will retain its looks and remain in good order. We will explain here how you should care for and clean your appliance correctly.

**WARNING**  
**Risk of electric shock!**

Penetrating moisture may cause an electric shock. Do not use any high-pressure cleaners or steam cleaners.

**WARNING**  
**Risk of burns!**

Never clean the appliance immediately after switching off. Let the appliance cool down.

**WARNING**  
**Risk of serious damage to health!**

Microwave energy may escape if the cooking compartment door or the door seal is damaged. Never use the appliance if the cooking compartment door or the door seal is damaged. Contact the after-sales service.

**NOTE:**

- *Slight differences in colour on the front of the appliance are caused by the use of different materials, such as glass, plastic and metal.*
- *Shadows on the door panel which look like streaks, are caused by reflections made by the oven light.*
- *Unpleasant odours, e.g. after fish has been prepared, can be removed very easily. Add a few drops of lemon juice to a cup of water. Place a spoon into the container as well, to prevent delayed boiling. Heat the water for 1 to 2 minutes at maximum microwave power.*

### Cleaning agents

To ensure that the different surfaces are not damaged by using the wrong cleaning agent, observe the information in the table. Do not use

- sharp or abrasive cleaning agents,
- metal or glass scrapers to clean the glass in the appliance door.
- metal or glass scrapers to clean the door seal,
- hard scouring pads and sponges ,
- cleaning agents with high concentrations of alcohol.

Wash new sponge cloths thoroughly before use.

Allow all surfaces to dry thoroughly before using the appliance again.

Area	Cleaning agents
Appliance front	Hot soapy water:  Clean with a dish cloth and dry with a soft cloth. Do not use glass cleaners or metal or glass scrapers for cleaning.
Appliance front with stainless steel	Hot soapy water :  Clean with a dish cloth and dry with a soft cloth. Remove flecks of limescale, grease , starch and albumin (e.g. egg white) immediately. Corrosion can form under such residues. Special stainless steel cleaning agents can be obtained from the after-sales service or from specialist shops. Do not use glass cleaners or metal or glass scrapers for cleaning.
Cooking compartment	Hot soapy water or a vinegar solution:  Clean with a dish cloth and dry with a soft cloth.  If the oven is very dirty: Do not use oven spray or other aggressive oven cleaners or abrasive materials. Scouring pads , rough sponges and pan cleaners are also unsuitable. These items scratch the surface. Allow the interior surfaces to dry thoroughly .
Recess in cooking compartment	Damp cloth:  Ensure that no water seeps through the turntable drive into the appliance interior.
Wire racks	Hot soapy water:  Clean using stainless steel cleaning agent or in the dishwasher.
Door panels	Glass cleaner:  Clean with a dish cloth. Do not use a glass scraper.
Seal	Hot soapy water:  Clean with a dish cloth, do not scour. Do not use a metal or glass scraper for cleaning.

## TECHNICAL DATA

Rated Voltage	230-240V ~50Hz
Maximum Power	3350W
Rated Output Power (Microwave)	900W
Rated Current	15 A
Oven Capacity	44L
Turntable Diameter	Ø 360mm
External Dimensions Without handle	595(W) x 568(D) x 458(H) mm
Net Weight Approx.	36kg

## TROUBLESHOOTING



### WARNING

#### Risk of electric shock!

Incorrect repairs are dangerous. Repairs may only be carried out by one of our trained after-sales engineers.

Problem	Possible cause	Remedy/information
The appliance does not work.	Faulty circuit breaker.	Look in the fuse box and check that the circuit breaker for the appliance is in working order.
	Isolation switch is off	Switch on the isolation switch
	Power cut	Check whether the kitchen light works.
The appliance does not work.  appears in the display panel.	Childproof lock is active.	Deactivate the childproof lock (see section: Childproof lock).
0:00 is in the display panel.	Power cut	Reset the clock.
The microwave does not switch on.	Door not fully closed.	Check whether food residue or debris is trapped in the door.
It takes longer than before for the food to heat up in the microwave	The selected microwave power level is too low.	Select a higher power level.
	A larger amount than usual has been placed in the appliance.	Double the amount = almost double the cooking time.
	The food was colder than usual.	Stir or turn the food during cooking.
Turntable grates or grinds.	Dirt or debris in the area around the turntable drive.	Clean the rollers under the turntable and the recess in the oven floor thoroughly.
A particular operating mode or power level cannot be set.	The temperature, power level or combined setting is not possible for this operating mode.	Choose permitted settings.
E 1 appears in the display panel.	The thermal safety switch-off function has been activated.	Call the after-sales service.
E 4 appears in the display panel.	The thermal safety switch-off function has been activated.	Call the after-sales service.
E 11 appears in the display panel.	Moisture in the control panel.	Allow the control panel to dry.
E 17 appears in the display panel.	Rapid heating has failed.	Call the after-sales service.



## ENERGY AND ENVIRONMENT TIPS

Here you can find tips on how to save energy when baking and roasting and how to dispose of your appliance properly.

### Saving energy

- Only preheat the oven if this is specified in the recipe or in the operating instruction tables.
- Use dark, black lacquered or enamelled baking tins. They absorb the heat particularly well.
- Open the oven door as infrequently as possible while you are cooking, baking or roasting.
- It is best to bake several cakes one after the other. The oven is still warm. This reduces the baking time for the second cake. You can also place two loaf tins next to each other.
- For longer cooking times, you can switch the oven off 10 minutes before the end of the cooking time and use the residual heat to finish cooking.

### Environmentally-friendly disposal



Dispose of packaging in an environmentally-friendly manner.

## INSTALLATION

### INSTALLATION FOR COMPACT OVEN

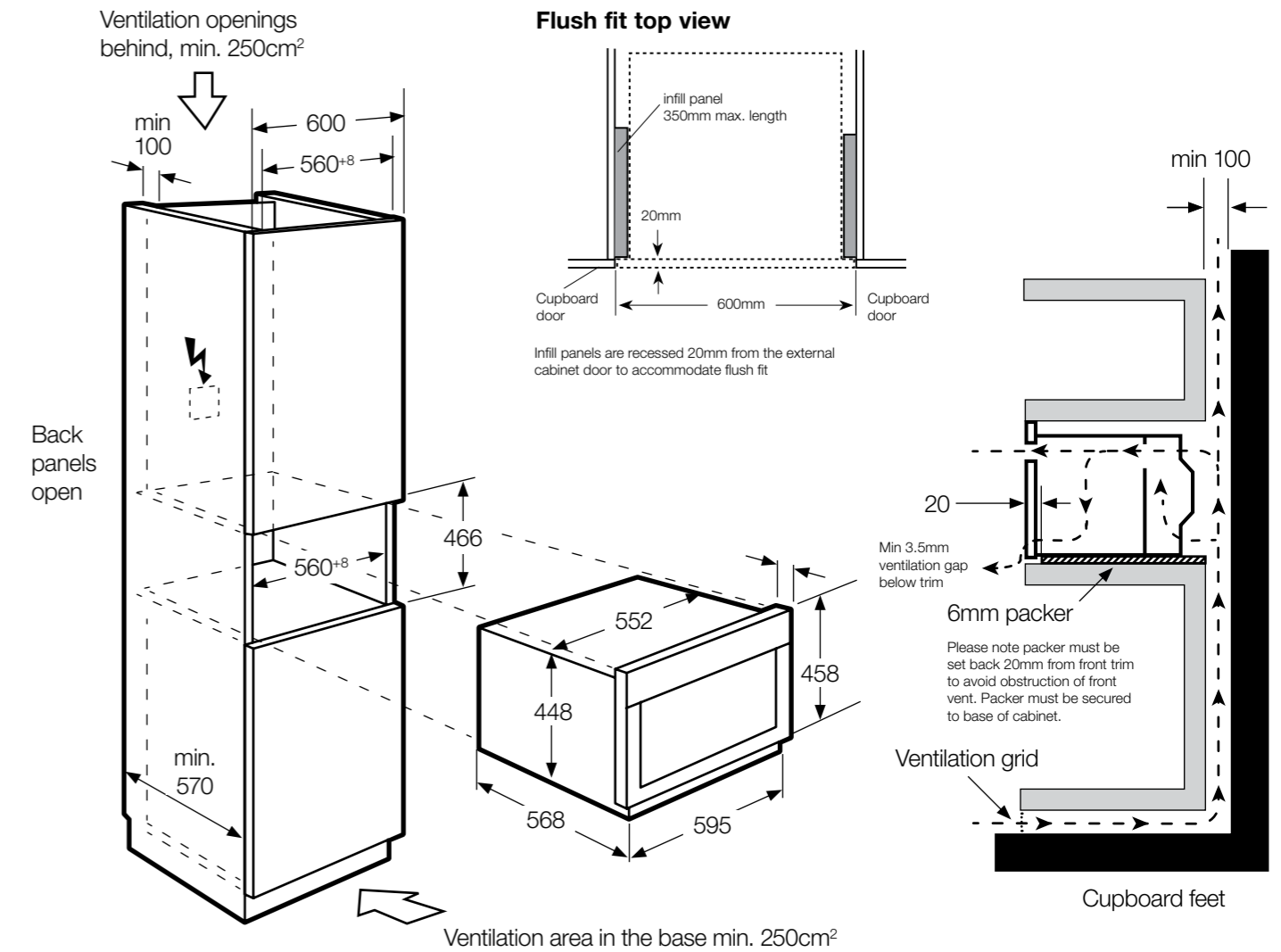

### Building in

- Do not hold or carry the appliance by the door handle. The door handle cannot hold the weight of the appliance and may break off.
  1. Carefully push the microwave into the box, making sure that it is in the centre.
  2. Open the door and fasten the microwave with the screws that were supplied.
- Fully insert the appliance and centre it.
- Do not kink the connecting cable.
- Screw the appliance into place.
- The gap between the worktop and the appliance must not be closed by additional battens.



### IMPORTANT

#### Electrical connection

This appliance is supplied with a 15A power cord without plug. It must be installed by a suitably qualified electrician in compliance with local regulations and wiring rules. An accessible all pole isolation switch with contact gap of at least 3mm must be supplied in installation wiring.

# INSTALLATION (CONTINUED)

## INSTALLATION FOR COMBINED COMPACT OVEN & WARMING DRAWER

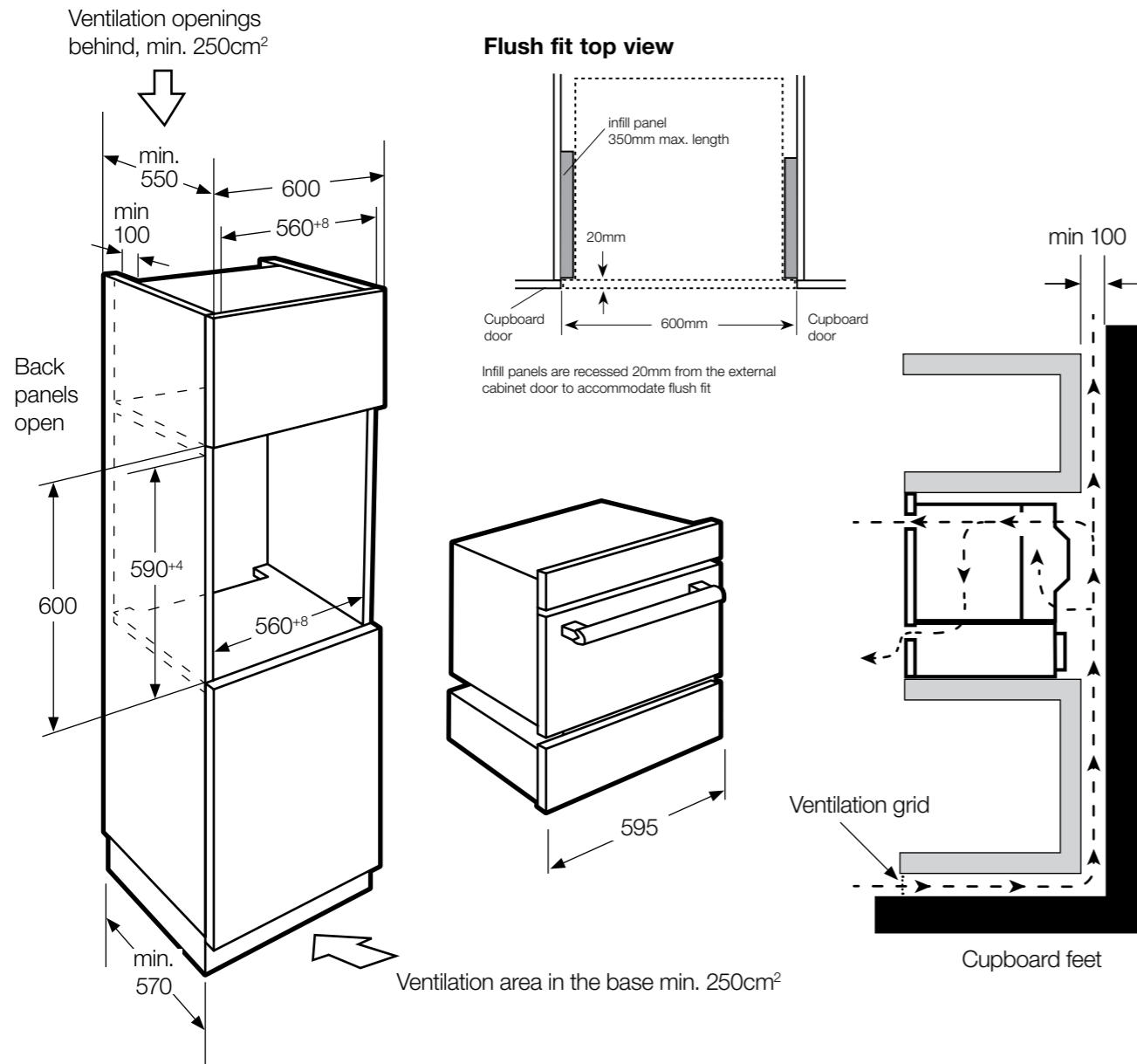

### Building in



**WARNING**  
The microwave oven is only compatible with certain Electrolux warming drawers (e.g. EWD1402DSD), do not install with a warming drawer that is not approved by Electrolux.

When building in with a compatible Electrolux warming drawer, please refer to the instructions supplied for the warming drawer for installation requirements.

The microwave oven can sit directly on top of the warming drawer (it does not need a separate base), then follow the installation requirements on the previous page for installing the microwave oven.



### IMPORTANT

#### Electrical connection

Refer to the instructions supplied with the warming drawer for electrical installation requirements of the warming drawer.

For electrical installation requirements of the microwave oven please refer to the previous page.



FOR SALES IN AUSTRALIA AND NEW ZEALAND  
APPLIANCE: ELECTROLUX BUILT-IN CONVECTION MICROWAVE AND BUILT-IN WARMING DRAWER

**This document sets out the terms and conditions of the product warranties for Electrolux Appliances. It is an important document. Please keep it with your proof of purchase documents in a safe place for future reference should there be a manufacturing defect in your Appliance. This warranty is in addition to other rights you may have under the Australian Consumer Law.**

#### 1. In this warranty:

- (a) 'ACL' or 'Australian Consumer Law' means Schedule 2 to the Competition and Consumer Act 2010;
- (b) 'Appliance' means any Electrolux product purchased by you and accompanied by this document;
- (c) 'ASC' means Electrolux's authorised serviced centres;
- (d) 'Westinghouse' is the brand controlled by Electrolux Home Products Pty Ltd of 163 O'Riordan Street, Mascot NSW 2020, ABN 51 004 762 341 in respect of Appliances purchased in Australia and Electrolux (NZ) Limited (collectively "Electrolux") of 3-5 Niall Burgess Road, Mount Wellington, in respect of Appliances purchased in New Zealand;
- (e) 'Warranty Period' means the period specified in clause 3 of this warranty;
- (f) 'you' means the purchaser of the Appliance not having purchased the Appliance for re-sale, and 'your' has a corresponding meaning.

**2. Application:** This warranty only applies to new Appliances, purchased and used in Australia or New Zealand and is in addition to (and does not exclude, restrict, or modify in any way) other rights and remedies under a law to which the Appliances or services relate, including any non-excludable statutory guarantees in Australia and New Zealand.

**3. Warranty Period:** Subject to these terms and conditions, this warranty continues for in Australia for a period of 24 months and in New Zealand for a period of 24 months, following the date of original purchase of the Appliance.

**4. Repair or replace warranty:** Repair or replace warranty: During the Warranty Period, Electrolux or its ASC will, at no extra charge if your Appliance is readily accessible for service, without special equipment and subject to these terms and conditions, repair or replace any parts which it considers to be defective. Electrolux or its ASC may use refurbished parts to repair your Appliance. You agree that any replaced Appliances or parts become the property of Electrolux

**5. Travel and transportation costs:** Subject to clause 7, Electrolux will bear the reasonable cost of transportation, travel and delivery of the Appliance to and from Electrolux or its ASC. Travel and transportation will be arranged by Electrolux as part of any valid warranty claim.

**6. Proof of purchase** is required before you can make a claim under this warranty.

**7. Exclusions:** You may not make a claim under this warranty unless the defect claimed is due to faulty or defective parts or workmanship. This warranty does not cover:

- (a) light globes, batteries, filters or similar perishable parts;
- (b) parts and Appliances not supplied by Electrolux;
- (c) cosmetic damage which does not affect the operation of the Appliance;
- (d) damage to the Appliance caused by:
  - (i) negligence or accident;

- (ii) misuse or abuse, including failure to properly maintain or service;
- (iii) improper, negligent or faulty servicing or repair works done by anyone other than an Electrolux authorised repairer or ASC;
- (iv) normal wear and tear;
- (v) power surges, electrical storm damage or incorrect power supply;
- (vi) incomplete or improper installation;
- (vii) incorrect, improper or inappropriate operation;
- (viii) insect or vermin infestation;
- (ix) failure to comply with any additional instructions supplied with the Appliance;

In addition, Electrolux is not liable under this warranty if:

- (a) the Appliance has been, or Electrolux reasonably believes that the Appliance has been, used for purposes other than those for which the Appliance was intended, including where the Appliance has been used for any non-domestic purpose;
- (b) the Appliance is modified without authority from Electrolux in writing;
- (c) the Appliance's serial number or warranty seal has been removed or defaced.

**8. How to claim under this warranty:** To enquire about claiming under this warranty, please follow these steps:

- (a) carefully check the operating instructions, user manual and the terms of this warranty;
- (b) have the model and serial number of the Appliance available;
- (c) have the proof of purchase (e.g. an invoice) available;
- (d) telephone the numbers shown below.

**9. Australia:** For Appliances and services provided by Electrolux in Australia: Electrolux goods come with guarantees that cannot be excluded under the Australian Consumer Law. You are entitled to a replacement or refund for a major failure and for compensation for any other reasonably foreseeable loss or damage. You are also entitled to have the Appliance repaired or replaced if the Appliance fails to be of acceptable quality and the failure does not amount to a major failure. 'Acceptable quality' and 'major failure' have the same meaning as referred to in the ACL.

**10. New Zealand:** For Appliances and services provided by Electrolux in New Zealand, the Appliances come with a guarantee by Electrolux pursuant to the provisions of the Consumer Guarantees Act, the Sale of Goods Act and the Fair Trading Act. Where the Appliance was purchased in New Zealand for commercial purposes the Consumer Guarantee Act does not apply.

**11. Confidentiality:** You accept that if you make a warranty claim, Electrolux and its agents including ASC may exchange information in relation to you to enable Electrolux to meet its obligations under this warranty. You accept that if you make a warranty claim, Electrolux and its agents including ASC may exchange information in relation to you to enable Electrolux to meet its obligations under this warranty. For more information on how we handle your personal information, see our privacy policy at [www.electrolux.com.au/other/privacy/](http://www.electrolux.com.au/other/privacy/) and [www.electrolux.co.nz/other/privacy/](http://www.electrolux.co.nz/other/privacy/)

#### Important Notice

Before calling for service, please ensure that the steps listed in clause 8 above have been followed.

<p><b>FOR SERVICE</b> or to find the address of your nearest authorised service centre in Australia <b>PLEASE CALL 13 13 49</b> <small>For the cost of a local call (Australia only)</small></p>	<p><b>AUSTRALIA</b> ELECTROLUX HOME PRODUCTS 163 O'Riordan Street, Mascot NSW 2020 electrolux.com.au</p>	<p><b>FOR SPARE PARTS</b> or to find the address of your nearest spare parts centre in Australia <b>PLEASE CALL 13 13 50</b> <small>For the cost of a local call (Australia only)</small></p>
<p><b>FOR SERVICE</b> or to find the address of your nearest authorised service centre in New Zealand <b>PLEASE CALL 0800 10 66 10</b> <small>(New Zealand only)</small></p>	<p><b>NEW ZEALAND</b> ELECTROLUX (NZ) Limited 3-5 Niall Burgess Road, Mount Wellington electrolux.co.nz</p>	<p><b>FOR SPARE PARTS</b> or to find the address of your nearest spare parts centre in New Zealand <b>PLEASE CALL 0800 10 66 20</b> <small>(New Zealand only)</small></p>

**Electrolux Home Products Australia**

telephone: 1300 363 640  
fax: 1800 350 067  
email: [customercare@electrolux.com.au](mailto:customercare@electrolux.com.au)  
web: [electrolux.com.au](http://electrolux.com.au)

**shop.electrolux.com.au**



**Electrolux Home Products New Zealand**

telephone: 0800 436 245  
fax: 0800 225 088  
email: [customercare@electrolux.co.nz](mailto:customercare@electrolux.co.nz)  
web: [electrolux.co.nz](http://electrolux.co.nz)



**To add a touch of professional inspiration to your home, visit [electrolux.com.au](http://electrolux.com.au) or [electrolux.co.nz](http://electrolux.co.nz)**

[electrolux.com.au](http://electrolux.com.au)



or [electrolux.co.nz](http://electrolux.co.nz)

