

Fully Integrated Dishwasher



Model: DW6031

- BLDC motor with 5 year warranty
- Multi tilt and split third row cutlery tray
- Sensor touch controls in finger print resistant stainless steel
- 15 place settings
- Self cleaning filter system
- LED interior lighting
- 8 wash programs with 24 optional variations
- Residual hot air drying with extra hot rinse cycle
- *Whisper* quiet 45dBa
- Up to 24 hour delayed start on hourly intervals
- Three option spray pattern, top bottom or both
- Space saving sliding detergent dispenser
- 70°C sanitation cycle / Operating light floor beam
- 15 minute super rinse and 30 minute wash fast
- Easy lift top basket for large platters
- Anti-overflow protection
- Height adjustable cabinet
- Energy rating 4 stars
- WELS water rating 5 stars
- 11.8 Litres per wash



15 place settings



Internal LED light



Third row cutlery tray



Whisper Quiet



Delayed start



5 year warranty



QUALITY ASSURED

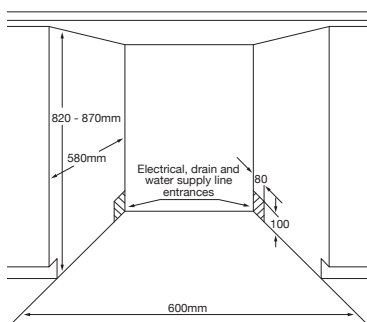

Door panel not included and is for illustration purposes only.

J10703_16

Level 2, 204 Botany Road, Alexandria NSW, 2015
 P: 02 9310 1207 • E: support@kleenmaid.com.au
www.kleenmaid.com.au

kleenmaid
 The best you can own