



Harlo

Bassinet "White"

Model # 036516-003



**IMPORTANT:
RETAIN FOR FUTURE REFERENCE,
READ CAREFULLY**

Read all instructions before assembly and use of the bassinet. Keep instructions for future use.

⚠ WARNING ⚠

FAILURE TO FOLLOW THESE WARNINGS AND THE INSTRUCTIONS COULD RESULT IN SERIOUS INJURY OR DEATH.

FALL HAZARD - TO PREVENT FALLS;

- **DO NOT USE THIS PRODUCT WHEN INFANT BEGINS TO PUSH UP ON HANDS AND KNEES OR HAS REACHED MANUFACTURER'S MAXIMUM WEIGHT OF 8KGS, WHICHEVER COMES FIRST.**

SUFFOCATION HAZARD - INFANTS HAVE SUFFOCATED;

- **IN GAPS BETWEEN EXTRA PADDING AND SIDE OF BASSINET /CRADLE, AND ON SOFT BEDDING.**
- **NEVER ADD A PILLOW, COMFORTER OR ANOTHER MATTRESS FOR PADDING.**
- **USE ONLY THE PAD PROVIDED BY MANUFACTURER.**

If sheet is used with the pad, use only the one provided by the bassinet manufacturer or one specifically designed to fit the bassinet.

To reduce the risk of Sudden Infant Death Syndrome (SIDS), paediatricians recommend healthy infants be placed on their backs to sleep, unless otherwise advised by your physician.

Use bassinet with only child at a time.

ALWAYS attach all provided fasteners (strings, straps, clamps etc...) tightly to the bassinet according to the instructions. Check frequently.

Strings can cause strangulation! **DO NOT** place items with a string around a child's neck, such as hood strings or pacifier cords. Do not suspend strings over a bassinet or attach strings to toys.

DO NOT leave child unattended in the bassinet.

ALWAYS make sure the wheels or stands are in the locked "down" position.

NEVER place bassinet near a window where cords from curtains can strangle a child.

Adult assembly is required.

Remove any tools or excess parts including plastic packaging from the bassinet vicinity after its assembly.

Discontinue use of the bassinet before the infant can sit up by themselves.

Padding and cushioning materials, including the mattress are to be sufficiently firm to preclude conforming to the contours of the infants face.

Ensure proper ventilation is maintained in and around the bassinet by limiting bed clothes, extra pillows or toys.

Ensure the bassinet is placed at a reasonable distance from curtains, blinds, heaters and power points.

Ribbons or lace associated with the bedding may entangle the infant.

Promptly replace worn out or broken parts.

Please keep medication, string, elastic, small toys or small items such as money out of reach from any position in the bassinet.

RECOMMENDED MATTRESS SIZE (SUPPLIED)

This bassinet has been manufactured for use with a mattress which measures 410mm wide x 770mm long x 30mm in thickness. The width and length are specified because it is important that the gaps between the mattress and the sides and ends of the bassinet will not exceed 40mm. This is to minimise the risk of a child's limb becoming caught in the gap.

Congratulations on your purchase of the **Harlo Bassinet** "White"

This product has been designed and developed with safety, comfort and functionality in mind. Please take the time to read this manual carefully before using this product and keep it in a safe place for future reference.

Contents

Assembly contents list

Assembly / Operating instructions

How to care for your **Harlo Bassinet**



Due to variations in the style and design of our products, the photographs and illustrations shown in this instruction manual are generic, therefore product fabrics, colour and design may vary from images shown. CNP Brands reserves the right to alter product specifications without notice as a result of our ongoing policy of product improvement.

Check what you have received...

You have received **1 box**. Please check the contents of the box against the list below. If anything is missing, please contact Customer Service.

In Australia, contact **CNP Brands on 1300 667 137**, in New Zealand contact **Wainhouse Distribution on 0800 567 5000**.

Supplied loose in box:

Top Frame
with Lining

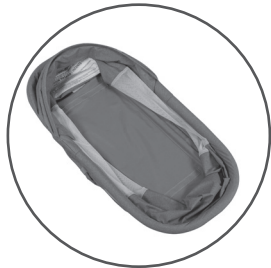

x 1

Mattress with
Sheet



x 1

Base Frame

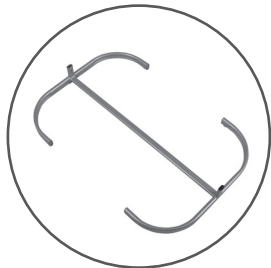

x 1

Side Supports

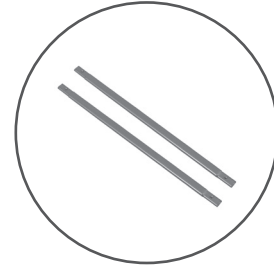

x 2

Castors

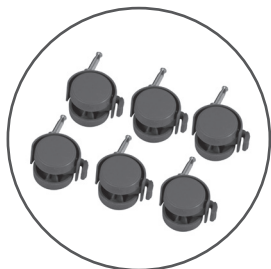

x 6

There are no accessories recommended for use with this Childcare Bassinet.

To assemble Bassinet Frame...

1

1a. Turn the Base Frame over and insert the 6 x Castors as shown.

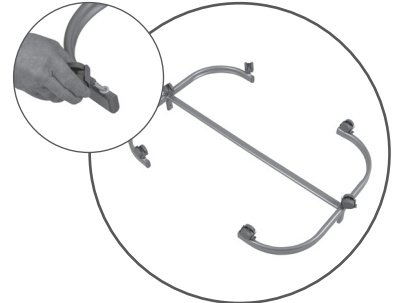

2

2a. Stand the frame upright and connect the Side Supports by pushing the spring pins in as you slide the supports into the Base Frame.

2b. Support is connected when the pin locks into the base.

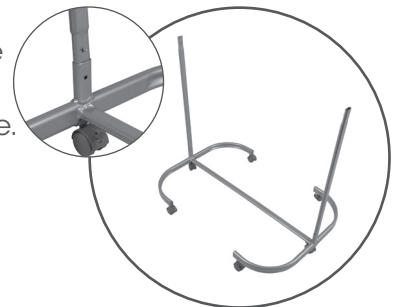

3

3a. Place the Top Frame onto the Side Supports, pushing the spring pins in to allow the Top Frame to sit in correctly.



4

4a. Secure press stud on bassinet to press stud on frame upright. **Ensure** this is done on both ends of the bassinet.

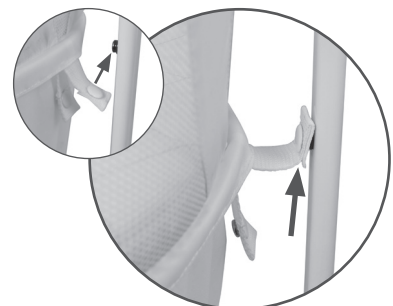

To insert Mattress Pad...

1

1a. Insert the Mattress into the liner.

1b. Press down to adhere the Velcro tabs on the Base with the Mattress.



To operate Canopy...

1

- 1a. The Hood has 2 x tabs with Velcro which attach to the side of the Top Frame.



To fold up Storage Shelf...

1

- 1a. The Storage compartment can be folded up by using the 4 x press studs which attach to the underside of the Liner.

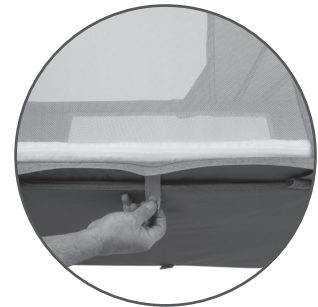

Note...

1

- 1a. Each castor has a locking lever to prevent Sleeper movement.
1b. Press the lever down to lock and lift up to release.



2

- 2a. Please make sure all tube connections are secure with the push pins visible in the hole in the connecting frames.

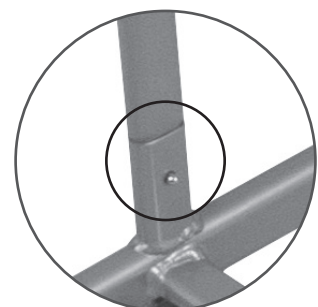

The bassinet is now ready for use.

Cleaning

To ensure the long-lasting use of your bassinet, dry it with a soft absorbent cloth after use. Use a damp cloth to clean the frame. Do not use abrasive cleaners. Allow it dry completely before folding or storing it away. Do not dry clean, or use bleach on fabrics or trims. Do not machine wash, tumble or spin dry, unless the care labelling on the product permits these methods.

Maintenance

Check bassinet regularly to ensure that locking devices and components are secure and working properly. Always check parts regularly for tightness of screws, nuts and other fasteners – tighten or replace if required. To maintain the safety of your bassinet, seek prompt repairs for bent, torn, worn or broken parts. Use only those parts and accessories approved by **CNP Brands**.

If you have any difficulties in assembling the bassinet, please contact our Service Department.

In Australia, contact **CNP Brands on 1300 667 137**, in New Zealand contact **Wainhouse Distribution on 0800 567 5000**.



CNP BRANDS

CHILDCARE NURSERY PRODUCTS | EST. 1899



Distributed in Australia by CNP Brands
Customer Service 1300 667 137

W: www.cnpbrands.com.au
E: info@cnpbrands.com.au
F: www.facebook.com/CNPBrands
I: @cnp_baby

Distributed in New Zealand by Wainhouse
Distribution
2-6 Argyle St, Morningside,
PO Box 41-014,
St Lukes, Auckland, New Zealand
Customer Service: 0800 567 5000

E: helpline@wainhousedist.co.nz

